



# Kimberly-Clark

# BLOCK-IT\*

## HOUSE WRAP



### General BLOCK-IT\* Recommendations:

- Store BLOCK-IT\* in a clean, dry, covered area until installation.
- Use a sharp razor knife to cut BLOCK-IT\*.
- Use a good quality C920 Class 25 caulk and/or flashing tape with acrylic or butyl adhesive for sealing windows, doors or penetrations.
- Due to the drainage properties of BLOCK-IT\* it is recommended that all seam and flashing tapes are rolled after installation with a J-roller to ensure proper bonding.
- Limit UV exposure to 6 months
- Whenever you are installing a product that could bond to BLOCK-IT\* such as stucco, cultured stone or brick, a release layer or building paper is recommended.





## Installation instructions:

1. Start at a corner install BLOCK-IT\* shingle fashion, fabric side facing out (Print side out). Ensure BLOCK-IT\* continues beyond the band joist and extends a minimum of 2" below the frame to foundation intersection. Use cap nails, cap staples or typical uncapped construction staples or roofing nails to attach. Fasteners should be installed no more than 24" OC. Fasteners should be 4" away from the sides and 12" away from the top of any window or door openings to leave room for flashing.
2. Continue to install BLOCK-IT\* ensuring sections overlap a minimum of 6" for horizontal joints and 12" for vertical joints.
3. Install the BLOCK-IT\* up beyond the attic and other unoccupied spaces to roofline and under trim ensuring that it properly integrates with all flashing. When trimming BLOCK-IT\* at roof to wall intersections, use a straight edge (2x material) as a guide.
4. BLOCK-IT\* should not be installed over saturated OSB unless there are provisions made for drying the structure. (i.e. leaving windows open on dry days, dry heat or dehumidification).
5. If a seam falls within 16" an outside corner extend the overlapping roll at least 24" beyond the corner.
6. If a seam falls within 16" an inside corner, extend the overlapping roll at least 24" beyond the corner.
7. Any and all penetrations should be flashed with the flashing product shingled under BLOCK-IT\*. Apply flashing tape with an acrylic or butyl adhesive to the vertical edges of the flap.
8. Any small tears in BLOCK-IT\* should be repaired with an acrylic adhesive seam tape.
9. All tears longer than 6" must be repaired by cutting a flap in BLOCK-IT\* 2" beyond the bottom and sides of the tear. Insert a wider piece of BLOCK-IT\* under the flap, shingle style and tape it on each side of the flap.

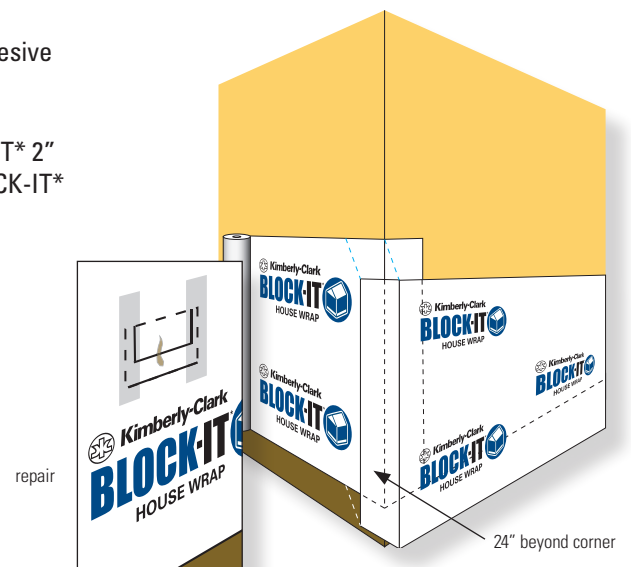
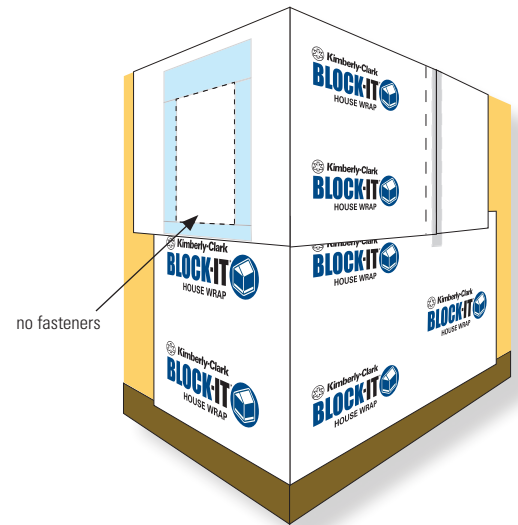
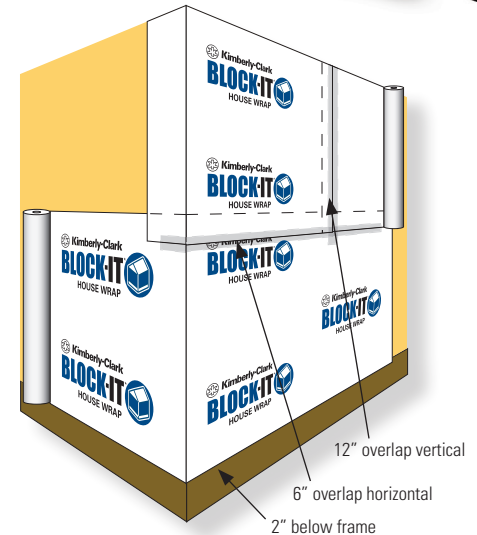





## General flanged window and flanged door installation instructions:

1. Cut BLOCK-IT\*, at the rough opening, in the shape of an upside down champagne glass. At the sill extend the cut 4" horizontally on each side of the rough opening. First, fold BLOCK-IT\* in at the bottom and sides.
2. Installation of a preformed sill pan is recommended under all doors and windows.
  - A. An alternate method to a preformed sill pan would be to use flexible flashing tape with an acrylic or butyl adhesive that conforms to the corners.
  - B. Install a piece of flashing tape with acrylic or butyl adhesive on the sill with a 12" piece of acrylic based flex tape at each corner, extending 6" up each side of the opening.
3. Fold the BLOCK-IT\* into the rough opening, and fasten it to the interior stud face. Seal the 4" horizontal seams with an acrylic adhesive seam tape where BLOCK-IT\* was cut.
4. At the head, make two 6" 45° cuts in BLOCK-IT\*.
5. Fold the BLOCK-IT\* up away from the rough opening, and temporarily tape it out of the way with an acrylic adhesive seam tape.
6. Apply a continuous bead of C920 Class25 rated caulk to the head and jambs ONLY. Install the window or door in the rough opening.
 

**NOTE:** caulk should not seep out from behind the flange.
7. Shim the window to achieve an even, continuous space between the window frame and the rough opening. Hold the window in place by nailing one of the top corners.
8. Check the window for plumb, level, and square. Confirm that the window opens and closes smoothly without sticking. Fasten the window to the frame per the manufacturer's instructions.

*Flanged window and flanged door installation instructions - continued on next page*

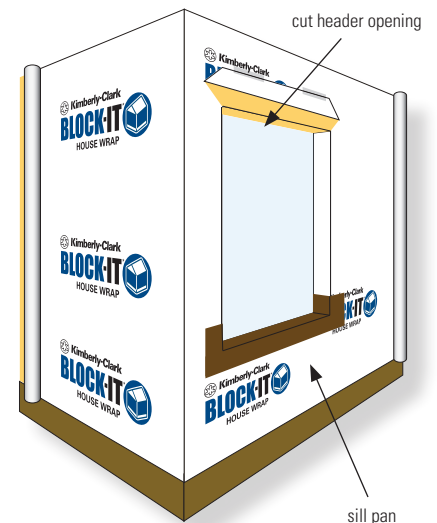
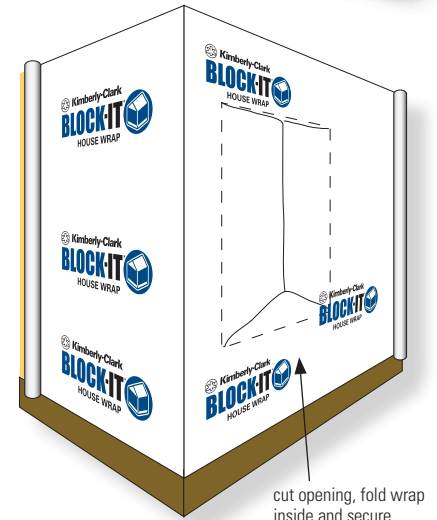



*continued* - **General flanged window and flanged door installation instructions:**

9. Apply flashing tape with acrylic or butyl adhesive over the jamb flanges and extend the flashing tape 2" above the window frame. Roller application recommended to ensure good adhesion between the flashing and the BLOCK-IT<sup>®</sup> House Wrap.
10. Apply flashing tape with acrylic or butyl adhesive over the flange at the head and extend the flashing tape 1" past the jamb flashing on each side of the opening.
11. Unfold BLOCK-IT<sup>®</sup> and seal the 45° cuts with an acrylic adhesive seam tape.
12. Optional Backdam: a backdam may be required on the interior side of the window unit at the sill. A preformed sill pan comes equipped with one, but if the alternative method is used, a backdam must be installed.

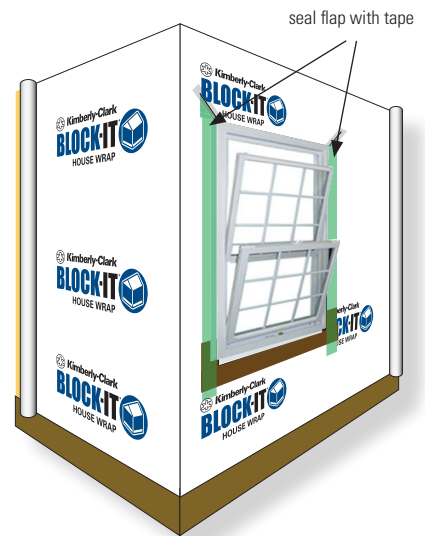
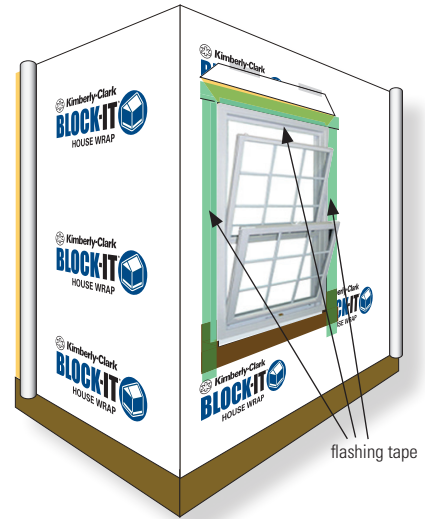



### Installation Instructions for Brick Mold Doors:

1. Prepare head flashing by cutting a length of acrylic or butyl flashing tape at least 12" longer than the head length. **Figure A**
2. Center the acrylic or butyl flashing tape across the length of the door head so it contacts the door frame and interior side of the brick mold or flange. Remove the release paper and adhere the acrylic or butyl flashing tape to the door frame using a roller to secure tape. **Figure B**
3. At the corner of the door frame, cut acrylic or butyl flashing tape at a 45° angle and fold flashing flap down flat against the brick space mold or flange. **Figure C**
4. Prepare jamb flashing by cutting a piece of acrylic or butyl flashing tape 6" longer than the jamb. **Figure D**
5. Center the acrylic or butyl flashing tape across the jamb where the acrylic or butyl flashing tape contacts the door frame and interior side of the brick mold or flange. Jamb flashing should be positioned 1.5" below the top edge of the head flashing. Jamb acrylic or butyl flashing tape must contact the head acrylic or butyl flashing tape by at least 1". **Figure D**
6. Remove the release paper and adhere the acrylic or butyl flashing tape to the door frame using a roller to secure tape. **Figure E**
7. Repeat on all jambs. **Figure F**

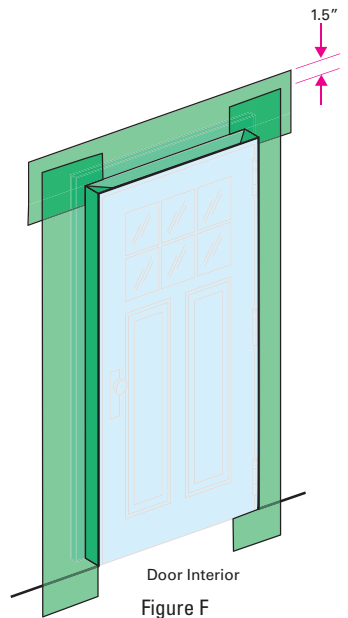
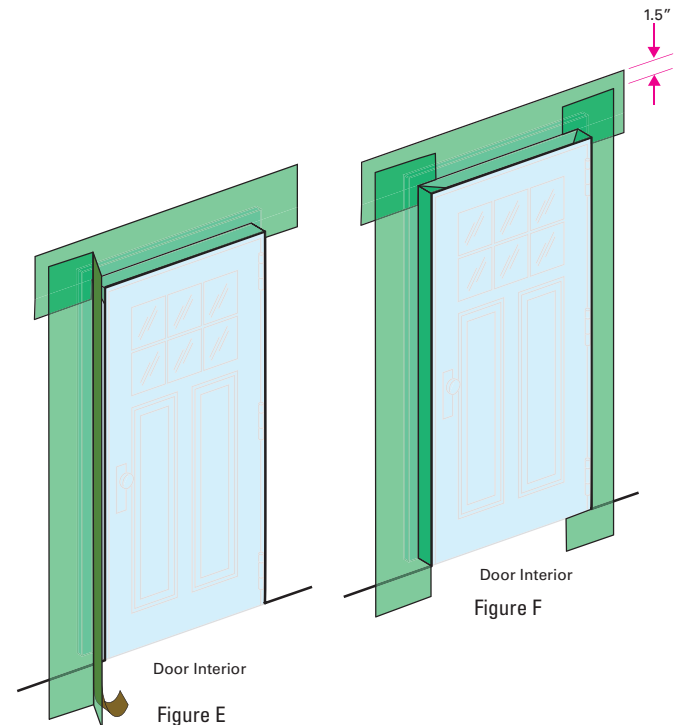
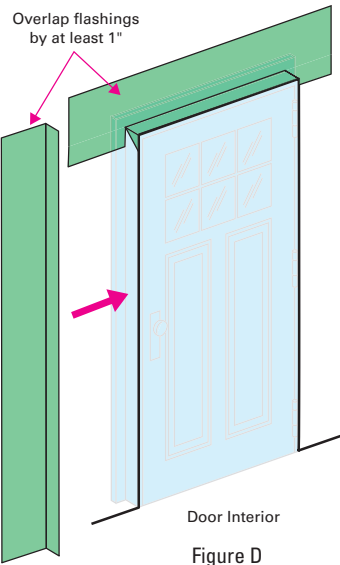
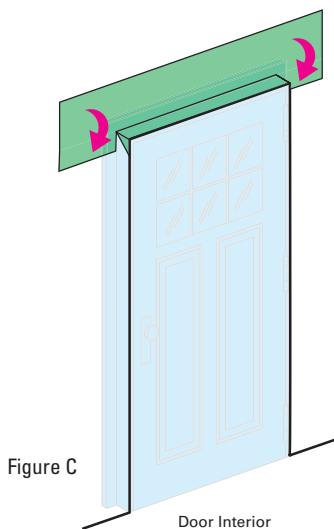
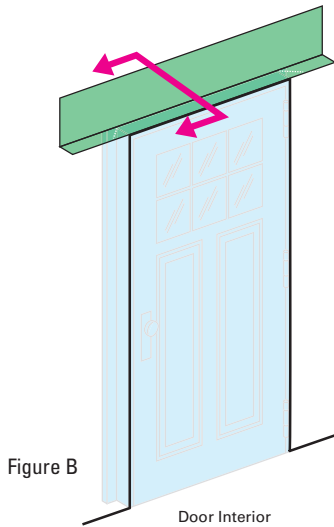
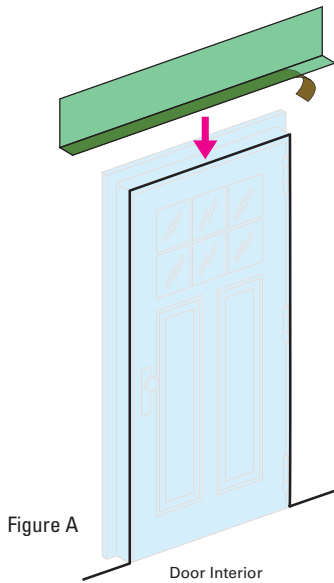

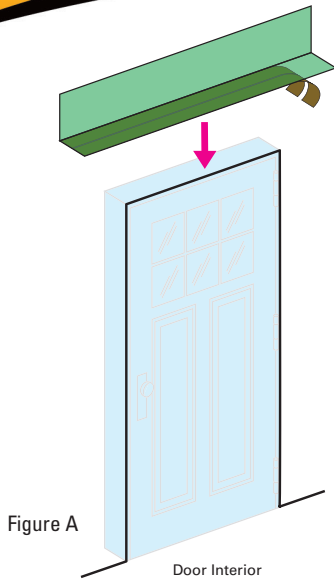

Figure A

Door Interior

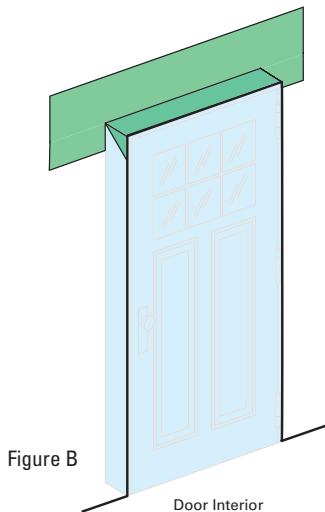
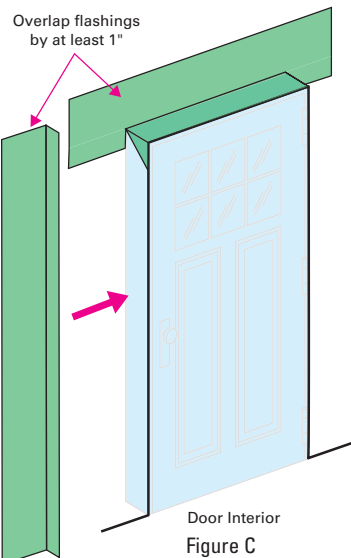

Figure B

Door Interior



6

Figure C

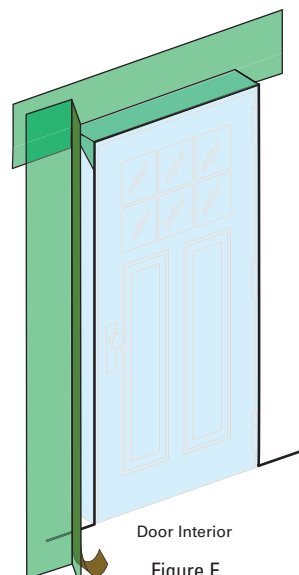

Figure E

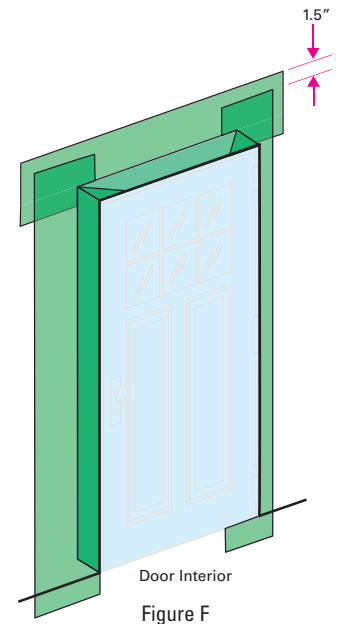

Figure F

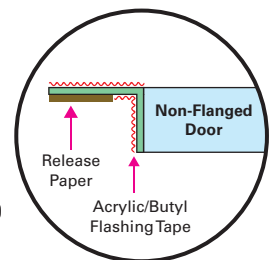

Figure D

### Installation Instructions for Non-flanged Doors Only:

1. Prepare head flashing by cutting a length of acrylic or butyl flashing tape at least 12" longer than the head length. **Figure A**
2. Center the acrylic or butyl flashing tape across the length of the door head so it contacts the door frame and interior side of the brick mold or flange. Remove the release paper and adhere the acrylic or butyl flashing tape to the door frame using a roller to secure tape. **Figure A**
3. Starting at the junction of the jamb and head away from the corners, cut the acrylic or butyl flashing tape along the corner at a 45° angle. **Figure B**
4. Fold the newly created flashing flaps down parallel to the door frame and fold remaining head acrylic or butyl flashing tape onto the jamb. **Figure B**
5. Prepare jamb flashing by cutting a piece of acrylic or butyl flashing tape 6" longer than the jamb. **Figure C**
6. Center the acrylic or butyl flashing tape across the jamb where the acrylic or butyl flashing tape contacts the door frame and interior side of the brick mold or flange. Jamb flashing should be positioned 1.5" below the top edge of the head flashing. Jamb acrylic or butyl flashing tape must contact the head acrylic or butyl flashing tape by at least 1". **Figure D**
7. Remove the release paper and adhere the acrylic or butyl flashing tape to the door frame using a roller to secure tape. **Figure E**
8. Repeat on all jambs. **Figure F**



### Final Installation Steps for both Brick Mold and Non-flanged Doors:

1. Beginning at the junction of the jamb and head and at the sill and jamb and away from the corners, cut the acrylic or butyl flashing tape along the corners at a 45° angle and adhere it to the flashing head and fold flap down parallel to the door frame. **Figure A**
2. Fold flashing flaps to the door frame and adhere and repeat on opposite jamb. **Figure B and C**
3. Cut two 3"x3" flexible flashing tape squares and add patches to the corner of the door. Secure patches in corners to the wooden head and jambs with staples. **Figure D**
4. Install door according to manufacturer's installation instructions. **Figure E**
5. Remove the remaining release paper from the acrylic or butyl jamb flashing tape and use roller to adhere to the BLOCK-IT<sup>®</sup> House Wrap.
6. Remove the release paper at the head and adhere it to the exterior sheathing or framing members.

Figure A

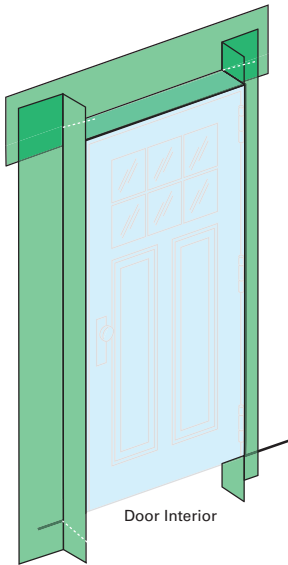

Figure B

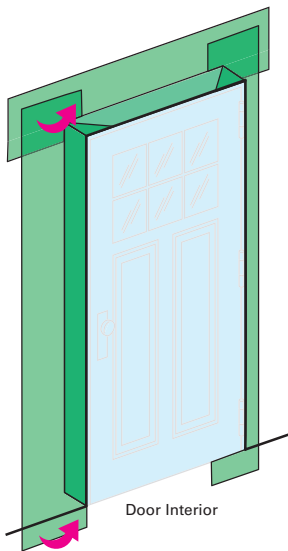

Figure C

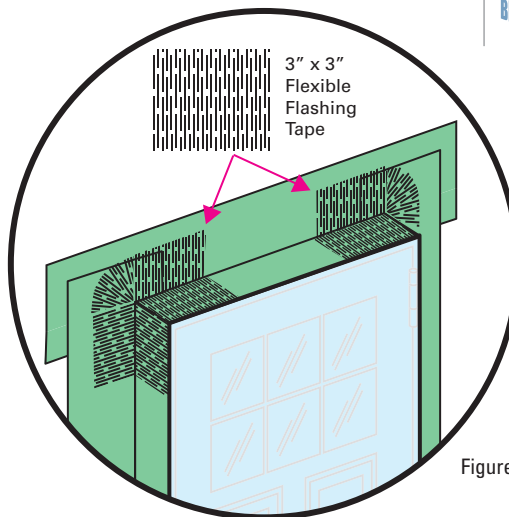
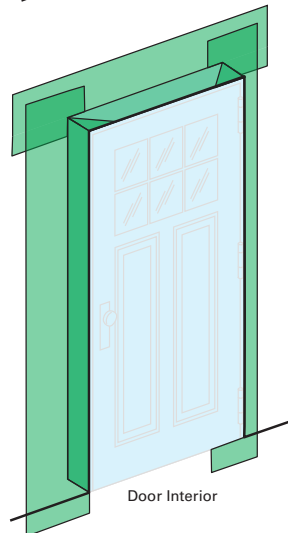

Figure D

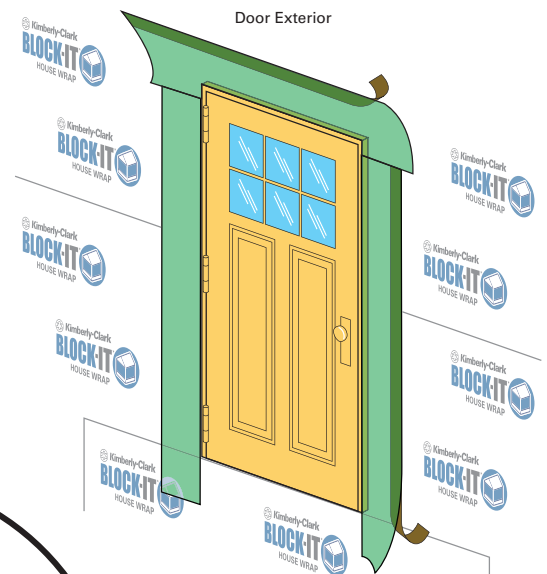

Figure E





## Best Practice Drip Cap Installation:

1. Cut a piece of metal or vinyl drip cap slightly longer than the width of the door and place a bead of C920 Class25 rated caulk on the rear side. Install the drip cap tightly against the door head and cover the top edge with acrylic or butyl flashing tape. **Figure A**

## Penetration Installation Instructions:

### Standard Penetration - pipes, wires

1. Cut a square flap in the BLOCK-IT\*, and temporarily tape it out of the way. Install the flashing panel over the pipe. Make sure the flashing panel is the correct size for the pipe. **Figure B**
2. Unfold the flap of BLOCK-IT\* over the flashing panel. Apply flashing tape with acrylic or butyl adhesive to the vertical edges of the flap. **Figure C**

### Flanged Penetration

1. Cut a square flap in the the BLOCK-IT\*, and temporarily tape it out of the way. Install the flanged assembly onto the sheathing. **Figure D**
2. Unfold the flap of the BLOCK-IT\* over the flanged penetration. Apply flashing tape with acrylic or butyl adhesive to the vertical edges and bottom of the flap, extending a minimum of 1" past the top and bottom of the flange. **Figure E**

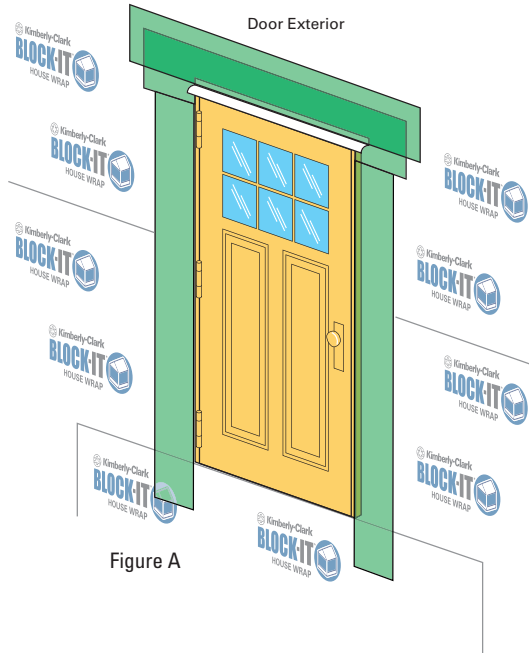

Figure A

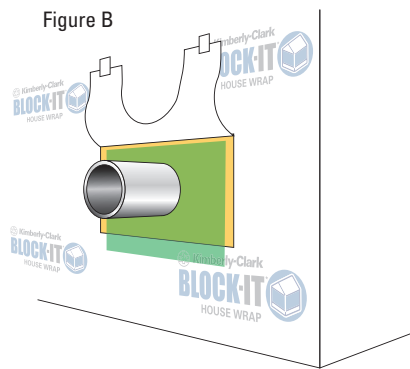

Figure B

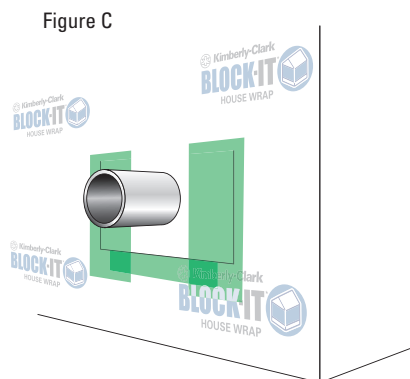

Figure C

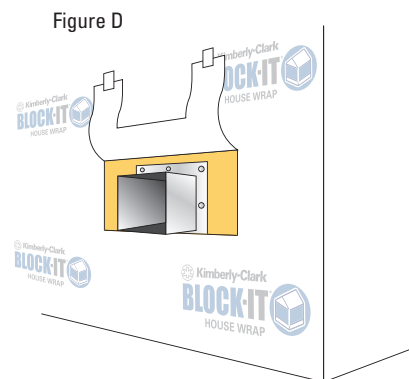

Figure D

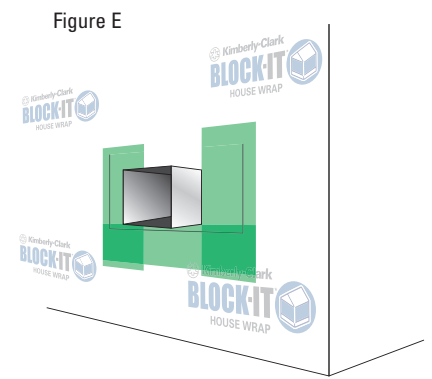

Figure E